

Article number: 4395000501

Description: Rota-fix shaft-hub connection F50x80  
Stainless steel

## Measures

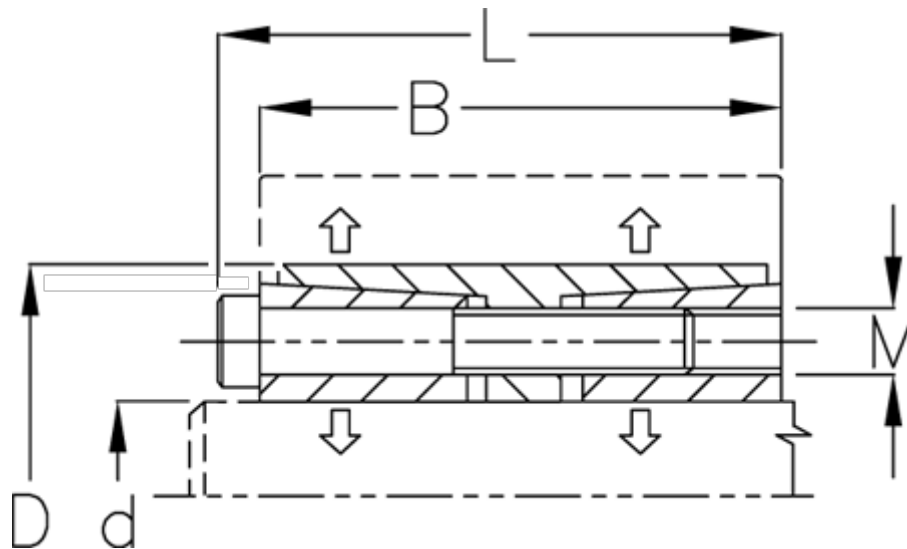

B mm	= 66
d H8 mm	= 50
D mm	= 80
Fit tolerance	= Aksel h8, Nav H8
F kN torque	= 87.7
L mm	= 74
M mm	= M8
P N/mm <sup>2</sup> surface pressure on shaft/hub	= 32

Surface roughness	= R? ? 3.2 μm
T N m torque	= 2190
Ts N m bolt tightening torque	= 28.7